

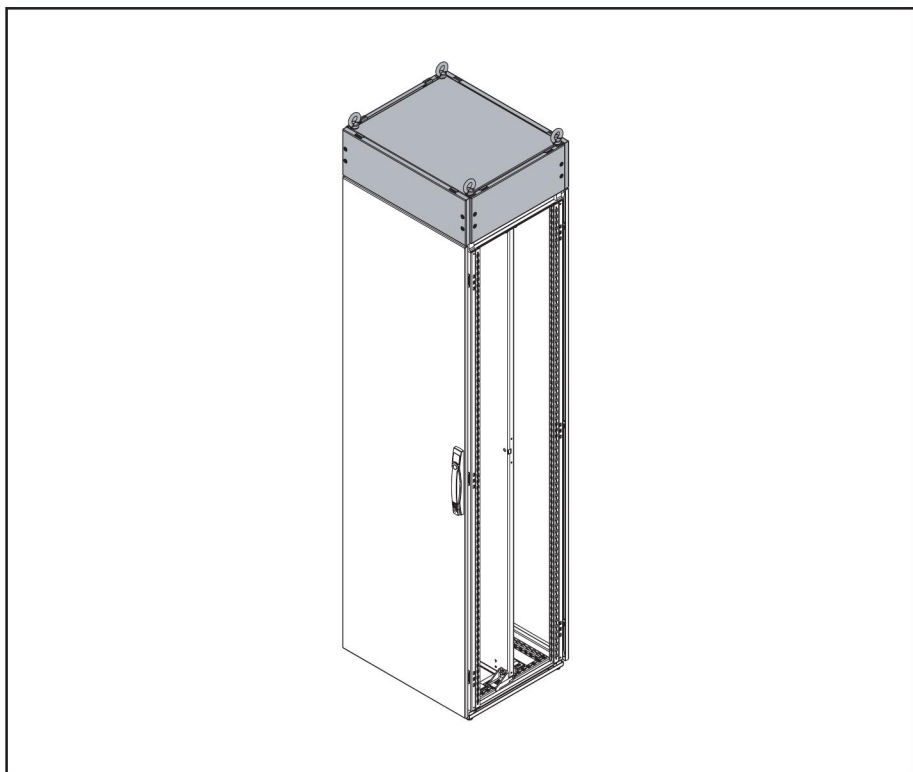

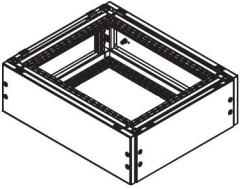





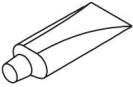

HOFFMAN

ProLine G2

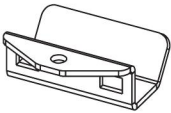

| | | |
|--------------------------------------------------------------------------------------------------------------------------|--------------------------------------------------------------------------------------------------------------------------|-------------------------------------------------------------------------------------------------------------------------|
| <p>1</p>  <p>(1x)</p> | <p>2</p>  <p>(3x)</p> | <p>3</p>  <p>(0x)</p> |
| <p>4</p>  <p>(1x)</p> | <p>5</p> <p>M8-1.25</p>  <p>(8x)</p> | <p>6</p> <p>M12</p>  <p>(0x)</p> |
| <p>7</p> <p>M8X1.25X25</p>  <p>(4x)</p> | <p>8</p> <p>M8X1.25X70</p>  <p>(4x)</p> | <p>9</p> <p>M12X3.175</p>  <p>(0x)</p> |
| <p>10</p>  <p>(8x)</p> | | |

